

Tech Spec 10



icpi

Interlocking Concrete
Pavement Institute®

Application Guide for Interlocking Concrete Pavements

This technical bulletin provides an overview of interlocking concrete pavements for a range of applications. The Interlocking Concrete Pavement Institute (ICPI) technical bulletins, brochures, design manuals and software are referenced to assist project owners, design professionals and contractors on design, construction and maintenance. Visit icpi.org for guide specifications and detail drawings for a range of applications

Product Description

Applications: Interlocking concrete pavements are appropriate for any application that requires paving. These areas include patios, driveways, pool decks, sidewalks, parking lots, pedestrian plazas, roof plaza decks, roof ballast, roof parking decks, embankment stabilization, gas stations, medians, streets, industrial pavements, ports, and airports. Vehicle speeds are generally 45 mph (70 kph) or lower.

Composition and Materials: Interlocking concrete pavers are composed of portland cement, fine and coarse aggregates. Color pigment is typically added. Admixtures are typically placed in the concrete mix to reduce the risk of efflorescence and improve durability. These materials are combined with a small amount of water to make a “zero slump” concrete. Pavers are made in factory-controlled con-

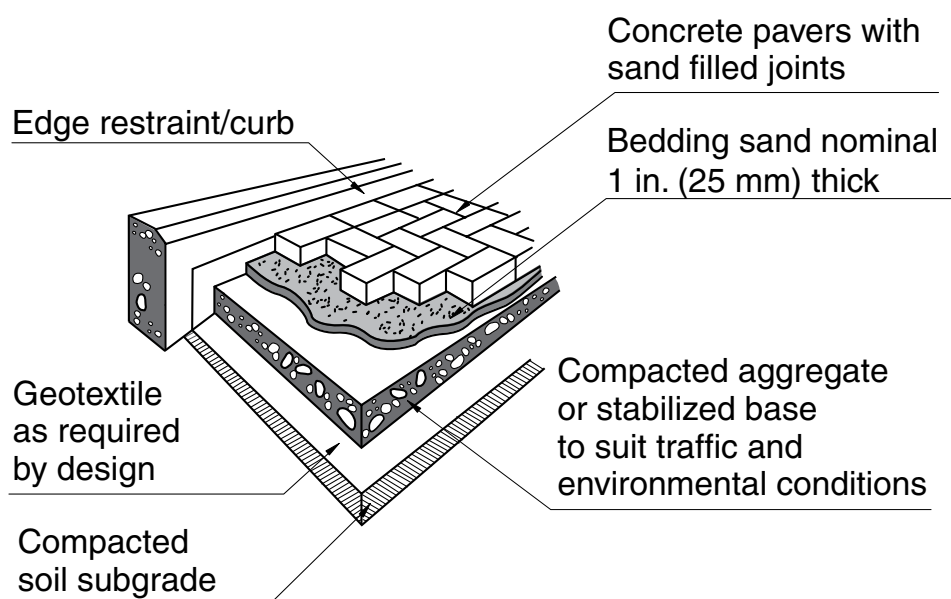

Figure 1. Typical components of an interlocking concrete pavement system

ditions with machines that apply pressure and vibration. The result is a consistent, dense, high strength concrete molded into many shapes. Special surface finishes can be produced to give an upscale architectural appearance. These include unique aggregates, colors, tumbling, shot blasting, bush hammering, and polishing.

Technical Data

Physical Characteristics: When manufactured in the U.S., interlocking concrete pavers made by ICPI members typically meet the requirements in ASTM C936, *Standard Specifications for Solid Interlocking Concrete Paving Units*. This standard defines concrete pavers as having a surface area no greater than 101 in.² (0.065 m²), and their overall length divided by thickness, or aspect ratio, does not exceed 4. The minimum thickness is 2 ³/₈ in. (60 mm).

Concrete pavers produced by Canadian ICPI members typically conform to Canadian Standards Association, CSA-A231.2, *Precast Concrete Pavers*. This standard defines a concrete paver as having a surface area less than or equal to 140 in.² (0.09 m²), an aspect ratio less than or equal to 4:1 for pedestrian applications, and less than or equal to 3:1 for vehicular applications. The minimum thickness is 2 ³/₈ in. (60 mm).

Design and Application Standards: For pedestrian applications and residential driveways, 2 ³/₈ in. (60 mm) thick pavers are recommended. Pavements subject to vehicular traffic typically require 3 ¹/₈ in. (80 mm) thick pavers. Some heavy-duty commercial pavements use minimum 4 in. (100 mm) thick units and sometimes 5 in. (120 mm) thick for the heaviest load applications.

Units with an overall length to thickness (aspect) ratio of 4:1 or greater should not be used in vehicular applications. Those with aspect ratios between 4:1 and 3:1 may be used in areas with limited automobile use such as residential driveways. Units with aspect ratios of 3:1 or less are suitable for all vehicular applications.

Interlocking concrete pavements are typically designed and constructed as flexible pavements on a compacted soil subgrade and compacted aggregate base. See Figure 1. Concrete pavers are then placed on a layer of bedding sand (1 in. or 25 mm thick), compacted, sand swept into the joints, and the units compacted again. When compacted, the pavers interlock, transferring vertical loads from vehicles to surrounding pavers by shear forces through the joint sand. The sand in the joints enables applied loads to be spread in a manner similar to asphalt, reducing the stresses on the base and subgrade.

Like other pavement systems, interlocking concrete pavement systems subject to vehicular applications require engi-

neered design. Structural design should follow ASCE Standard 58-10 *Structural Design of Interlocking Concrete Pavement for Municipal Streets and Roadways* based on AASHTO flexible pavement design. In addition, *ICPI Tech Spec 4—Structural Design of Interlocking Concrete Pavements* provides flexible and rigid pavement design guidance. ICPI provides structural design software that follows the ASCE design standard as well and a mechanistic design-based program called Lockpave for streets and industrial pavements.

In addition, structural design for ports and container areas should follow the ICPI manual, *Port and Industrial Design with Concrete Pavers*, based on the British Ports Association design method. Airfield pavement design should follow the procedures in the ICPI manual, *Airfield Pavement Design with Concrete Pavers*. This manual applies U.S. Federal Aviation Administration design procedures to interlocking concrete pavements. ICPI publishes a manual of the same name for design of airfields in Canada. The manual follows Public Works Canada design methods. For street, industrial, port and airport pavement designs, consult with a qualified civil or geotechnical engineer familiar with local soils, pavement design methods, ICPI resources, materials, and construction practices.

Benefits: As interlocking concrete pavements receive traffic, they stiffen and increase their structural capacity over time. The structural contribution of the interlocking pavers and sand layer can exceed that of an equivalent thickness of asphalt. The interlock contributes to the structural performance of the pavement system. *ICPI Tech Spec 4—Structural Design of Interlocking Concrete Pavements* provides additional information on structural design of the pavers, bedding sand, and base. ICPI takes a conservative approach by not recognizing differences among shapes with respect to structural and functional performance. Certain manufacturers may have materials and data that discuss the potential benefits of shapes that impact functional and structural performance.

Concrete pavers arrive at the site ready to install, ready for traffic immediately after installation. This can reduce construction time and restore access quickly. The joints between each paver help reduce cracking occurrence typically seen on conventional asphalt and concrete pavement.

Unlike concrete or asphalt, concrete pavers do not rely on monolithic continuity of their material for structural integrity. Therefore, utility cuts can be reinstated without damage to the pavement surface. *ICPI Tech Spec 6—Reinstatement of Interlocking Concrete Pavements* covers this topic in detail. Repair to underground utilities and to local deformations in the base materials can be accessed by removing and later reinstating the same pavers. No pavement materials are wasted or hauled to the landfill. Jackhammers are not required to

open interlocking pavements. The modular units enable changes in the layout of the pavement over its life.

Colored units can be used for lane and parking delineations, traffic direction markings, utility markings, and artistic super graphic designs. Various colors, shapes, textures and laying patterns can help direct pedestrians and calm vehicular traffic in urban areas. Pavers can be manufactured with detectable warnings for use on pedestrian curb ramps at intersections or at rail platforms and crossings.

The chamfered joints in the pavement surface facilitate removal of surface water. This decreases nighttime glare when wet and enhances skid resistance. *ICPI Tech Spec 13–Slip and Skid Resistance of Interlocking Concrete Pavements* includes information on slip and skid resistance. Snow is removed as with any other pavement. Concrete pavers can have greater resistance to deicing salts than conventional paving materials due to high cement content, strength, density, and low absorption.

Sustainable Aspects: Interlocking concrete pavements can be eligible for LEED® credits including those under Sustainable Sites (e.g., high solar reflectance index), Materials & Resources. See *ICPI Tech Spec 16–Achieving LEED® Credits with Segmental Concrete Pavement*. In addition, permeable interlocking concrete pavements can earn Sustainable Site credits for reducing runoff and water pollution. See the ICPI manual, *Permeable Interlocking Concrete Pavements* for design, specification, construction and maintenance guidelines, or *ICPI Tech Spec 18–Construction of Interlocking Concrete Pavements*.

Installation

Installation should be performed by experienced contractors who hold a current certificate in the ICPI Concrete Paver Installer Certification Program. Contractors holding this certificate have been instructed and tested on knowledge of interlocking concrete pavement construction. ICPI guide specifications available on www.icpi.org and project specifications should require that the job foreman hold this certificate and be present on the job site during paver installation. A certified installer with an Advanced Residential Paver Technician and/or Commercial Paver Technician designation has demonstrated knowledge of best construction practices for these applications. Project specifications should reference these contractor qualifications as well.

The installation guidelines below apply to pedestrian and vehicular applications.

Soil Subgrade: Once excavation is complete, the soil subgrade should be compacted prior to placing the aggregate base. Compaction should be at least 98% Proctor density (per

ASTM D698) for pedestrian areas and residential driveways, and at least 98% modified Proctor density (per ASTM D1557) for areas under constant vehicular traffic. Consult compaction equipment manufacturers' recommendations for applying the proper equipment to compact a given soil type. Geotextiles are sometimes used to separate fine subgrade soils from the base/subbase material. Geotextiles should be selected using AASHTO M-288 *Geotextile Specification for Highway Applications*. Geotextiles can help reduce the onset of deformation.

Some soils may not achieve these recommended minimum levels of density. These soils may have a low bearing capacity or be continually wet. If they are under a base that will receive constant vehicular traffic, the soils may need to be stabilized, or have drainage designed to remove excess water.

Aggregate Base: Aggregate base materials should conform to that used under asphalt. If no local, state, or provincial standards exist, then the requirements for aggregate base in ASTM D2940 are recommended. Compacted lift thickness is based on the force of the compaction equipment. Minimum lift thickness are typically between 4 to 6 inches. Consult with compaction equipment manufacturers for minimum lift thickness recommendations. The thickness of the base depends on the strength of the soil, drainage, climate, and traffic loads. Base thickness used under asphalt can typically be used under interlocking concrete pavers. Minimum aggregate base thickness for walks should be 4 to 6 in. (100 to 150 mm), driveways 6 to 8 in. (150 to 200 mm), and streets 8 to 12 in. (200 to 300 mm). Thicknesses may be greater depending on site conditions, freezing temperatures, and traffic (typically defined at 18,000 lb. or 80 kN equivalent single axle loads), as well review by a qualified design professional.

Aggregate base compaction under pedestrian and residential driveway pavements should be at least 98% of standard Proctor density (per ASTM D698). The aggregate base should be compacted to at least 98% modified Proctor density (per ASTM D1557) for vehicular areas. Compaction equipment suppliers can provide information on the appropriate machines for compacting base material. These density recommendations for areas next to curbs, utility structures, lamp bases, and other protrusions in the pavement are essential to minimize settlement. Site inspection and testing of the compacted soil and base materials are recommended to ensure that compaction requirements have been met. Compacted base materials stabilized with asphalt or cement may be used in heavy load applications or over weak soil subgrades. The surface of the compacted base should be smooth with a maximum tolerance of $\pm 3/8$ in. (10 mm) over a 10 ft. (3 m) straight-edge.

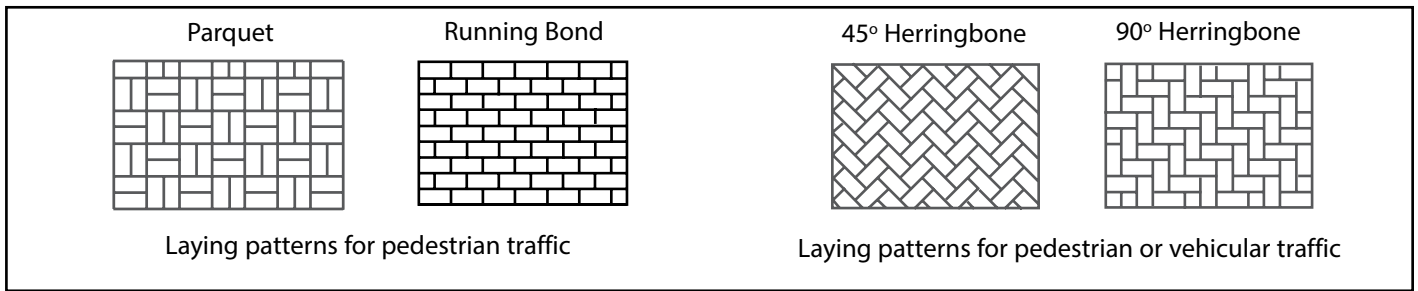

Figure 2. Typical laying patterns.

Bedding Sand: Bedding sand should conform to the grading requirements of ASTM C33 or CSA-A23.1-FA1. Do not use mason sand because it can be slow draining and unstable. Stone dust or waste screenings should not be used, as they can have an excessive amount of material passing the No. 200 (0.075 mm) sieve. *ICPI Tech Spec 17–Bedding Sands for Vehicular Applications* provides additional guidance on evaluating bedding sands under vehicular traffic. The sand should be screeded to 1 to 1½ in. (25 to 40 mm) uncompacted, consistent thickness. Do not use the sand to fill depressions in the base. These eventually will be reflected in the surface of the finished pavement. Fill any depressions with base material and compact.

Geotextile is recommended in the following places to prevent migration into joints and cracks. These areas are adjacent to curbs, roof parapets, drains, utility structures, and over asphalt or cement stabilized bases. When applied in these locations the fabric should be turned up against vertical surfaces to contain the bedding sand. Bedding sand drainage should be accomplished with weep holes through stabilized, asphalt or concrete bases, or through curbs, and typically placed at the lowest elevations.

Joint Sand: Bedding sand may be used as joint sand; dry sand may be used that conforms to the grading requirements of ASTM C144 or CSA-A179. This sand is often called mason sand and is used to make mortar. This sand should not be used for bedding sand.

Concrete Pavers: The shape of the concrete pavers determines the range of laying patterns (Figure 2). 45° or 90° herringbone patterns are recommended in areas subject to continual vehicular traffic. They provide maximum interlock and structural performance. Some patterns have “edge” pavers specifically designed to fit against the pavement edge. Concrete pavers are cut with a masonry saw to fit. Cut pavers should be no smaller than one-third of a unit when exposed to vehicular traffic. Joints between (cut or uncut) concrete pavers are typically 1/16 to 3/16 in. (2 to 5 mm) wide. They can be 1 to 2 mm wider for units in pedestrian areas with a stone like finish with rough edges and sides. Bond or joint lines

tolerances should be +/- 1/2 in. over a 50 ft. (15 m) string line.

Once the pavers are placed in their specified pattern(s), they are compacted into the bedding sand with a plate compactor. The compactor should have a minimum force of 5,000 lbs. (22 kN) and frequency of 75 to 100 hz. A protective pad on the compactor plate may be required to minimize the risk of etched paver surfaces during compaction. After the pavers are compacted, sand is swept and vibrated into the joints until they are full. All pavement not within 6 ft. (2 m) of unfinished edges should have the joints full and be compacted by the end of each day. Final surface elevations of the pavers should be 1/8 to 1/4 in. (3 to 6 mm) above edges to allow for minor settlement. Final surface elevations around drains should not exceed 1/4 in. (6 mm) in pedestrian areas but may be as much as 3/8 in. (10 mm) in vehicular areas. Paver-to-paver lippage should not exceed 1/8 in. (3 mm). See *ICPI Tech Spec 2–Construction of Interlocking Concrete Pavements* for further information on construction. *ICPI Tech Spec 9–Guide Specifications for the Construction of Interlocking Concrete Pavements* provides a guide specification for installation. Detail drawings and other guide specifications are available at the ICPI web site, icpi.org.

Edge Restraints: Edge restraints around interlocking concrete pavement are essential to their performance. The pavers and sand are held together by them, enabling the system to remain interlocked. For walks, patios, and driveways, edge restraints can be steel, aluminum, troweled concrete and submerged concrete curb, or plastic edging specifically designed for concrete pavers. Concrete restraints are recommended for crosswalks, parking lots, drives, streets, industrial, port, and airport pavements. Precast concrete and cut stone curbs are suitable for streets, drives, and parking lots. Edge restraints are typically placed before installing the bedding sand and concrete pavers. Some edge restraints such as plastic, steel, and aluminum can be installed after placing the concrete pavers. These edge restraints will require the compacted base to extend past the stakes that secure edging in the base. For residential projects, the distance from the stakes to the base perimeter should be consistent, not be greater than 10 in. (250

mm). For commercial applications, the distance should equal the base thickness. See *ICPI Tech Spec 3–Edge Restraints for Interlocking Concrete Pavements* for further information on edge restraints.

Drainage: Surface and subsurface drainage systems, as well as pavement grades, should conform to that used for any other flexible pavement.

Swimming Pools: High slip-resistance and rapid drainage of water make concrete pavers a desirable surface around commercial or residential swimming pools. A minimum 4 in. (100 mm) thick concrete base is typically used around pools when backfill soils or an aggregate base cannot be adequately compacted. Slope paver surfaces and bases towards stormwater drains. Such drains must have holes or slots at the bedding sand level to drain excess moisture from it. These openings should be covered with geotextile to prevent bedding sand loss. Vertical weep holes may be required through a concrete base at the lowest elevations, usually placed next to curbs. Typically, 2 in. (50 mm) diameter holes are cast or cored then filled with washed pea gravel and covered with geotextile to prevent bedding sand loss. A urethane or neoprene sealant and backer rod typical to pool construction should be placed between the course of pavers and the pool coping. This prevents water from entering this joint while allowing for differential movement between the pool wall and the adjacent pavement. Sealing the pavers and joints is recommended to keep sand in place

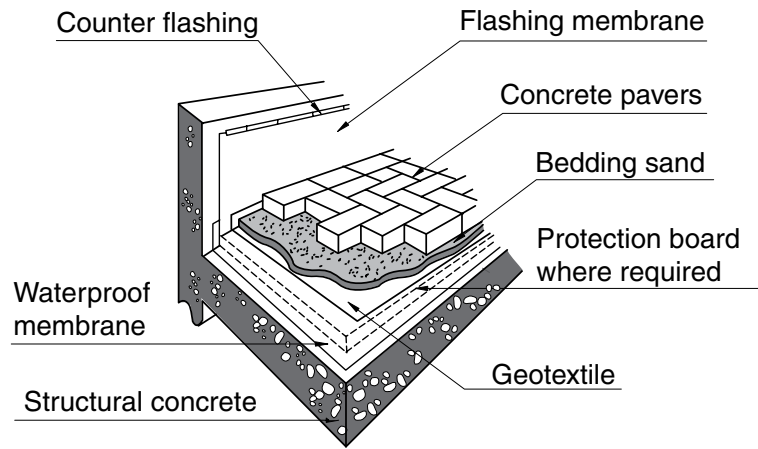

Figure 3. Roof assembly

Roof Plaza/Parking Decks: Interlocking concrete pavements can be placed on parking garage roofs and pedestrian roof plazas. Concrete pavers provide an attractive ballast for the waterproof membrane (Figure 3). As a heat sink, the pavers reduce thermal stress on the membrane. The roof structure should be waterproofed, designed to withstand pedestrian or vehicular loads as well as wind loads, and be sloped at least 2% to drain. Protection board should be applied according to the recommendations of the waterproof membrane manufacturer. Geotextile is applied around roof drains to prevent the migration of bedding sand. The drains should have holes at the level of the waterproof membrane to allow removal of subsurface water (Figure 4). Drainage mats are not recommended for roof decks subject to vehicular traffic. See *Tech Spec 14–Concrete Paving Units for Roof Decks* for further information on roof plaza deck applications including

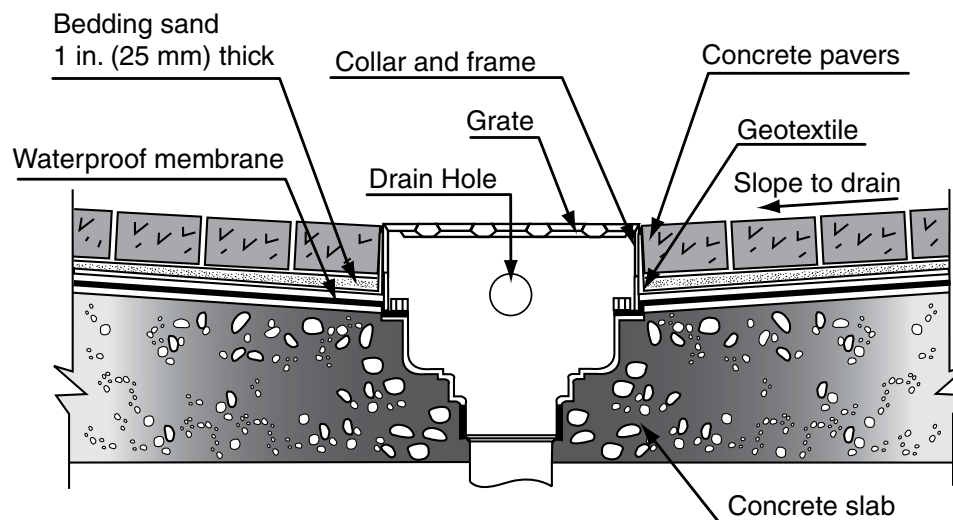

Figure 4. Roof drain holes at bottom of bedding sand layer

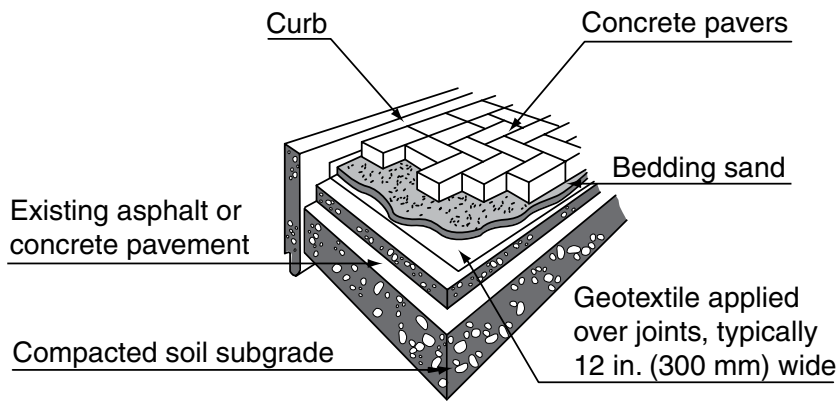

Figure 5. Typical overlay/inlay on existing pavement.

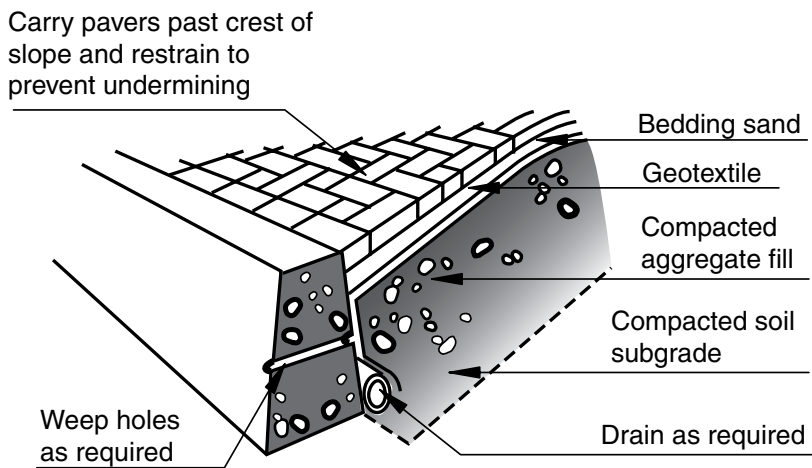

Figure 6. Embankment with concrete pavers

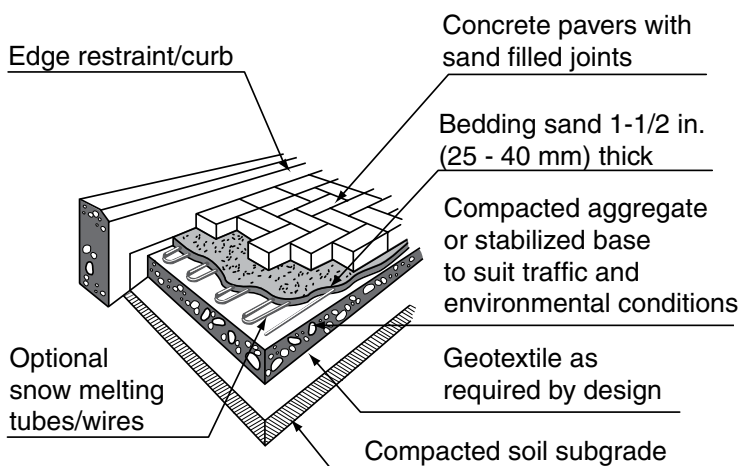

Figure 7. Snow melting system with concrete pavers for pedestrian areas or residential driveways

those with pedestals and paving slabs.

Pavement Overlay/Inlay: New or existing asphalt or concrete pavements can be overlaid or inlaid with concrete pavers (Figure 5). The surface of the existing pavement can be ground out and bedding sand and pavers placed in the milled area. Consideration should be given to draining excess moisture in the bedding sand. Drainage can be achieved by drilling/casting vertical holes at the lowest elevations of the pavement, or directing drain holes to catch basins. The drain holes should be covered with geotextile to prevent loss of bedding sand. Drainage into impervious or expansive soils will require piping drain holes to a storm sewer or other appropriate outlet. Geotextile may need to be applied at pavement joints and cracks. Cracks $\frac{3}{8}$ in. (10 mm) or larger in width should be patched prior to placing geotextile, bedding sand, and pavers. Thin paving units, $1\frac{1}{4}$ to $1\frac{3}{4}$ in. (30 to 45 mm) thick, have been used in overlays. The units are typically sand set on or adhered to a concrete base for pedestrian applications. They are not recommended for any vehicular application.

Embankments and Vehicular Pavements with High Slopes: Pavers provide a durable surface for control of soil erosion from embankments. A backfill of open-graded aggregate with drains at the bottom of the slope is recommended to relieve hydrostatic pressure (Figure 6). Concrete pavers restrained at the sides and top of the slope should have adjacent areas graded and slope in such a manner that water runs away from the restraints.

Vehicular pavements with slopes over 8% may require concrete header beams. Concrete header beams are recommended at the top and bottom of the sloped area. Intermittently placed beams along the sloped area are not recommended. Drainage of water in the bedding sand and base is essential along the upslope side of the concrete headers. For concrete pavers and bedding sand over aggregate base, removal of water can be accomplished

with minimum 1 in. (25 mm) diameter horizontal weep holes spaced every 10 ft. (3 m) and covered with geotextile to prevent loss of base fines or bedding sand. When pavers and bedding are over concrete or asphalt, there should be several vertical, geotextile-covered drain holes in these pavements on the upslope side of the header. The water collected by these drain holes or geocomposite drains should be directed beyond the edge restraints of the pavement.

The overall dimensions of, and the steel reinforcement within, the concrete headers will depend upon traffic loads and base design. Minimum recommended dimensions are 6 in. (150 mm) wide and 12 in. (300 mm) deep. The joint sand between the pavers should be stabilized to prevent washout. The crossfall of the pavement should be at least 2% from the center.

Snow Melting Systems: Interlocking concrete pavements can accommodate snow melting systems for pedestrian and vehicular applications (Figure 7). The systems consist of hot, liquid-filled tubing or radiant wires placed in the bedding sand, in compacted aggregate or concrete bases. Snow melt systems can turn on automatically when a snowstorm starts, eliminating plowing, ice hazards, and the need for de-icing salts. The result is less potential for injuries from slipping on ice and decreased liability.

An aggregate base can be used to support the tubing or wires for pedestrian areas and residential driveways. Both systems must be secured to the base prior to placing the bedding sand. The systems are installed by specialty contractors (electricians and/or plumbers). The bedding sand may be as much as 2 in. (50 mm) thick to cover and protect the tubing or wires. For other vehicular areas, the tubing or wires should be placed in a concrete or asphalt base and these bases require drain holes at the lowest elevations. See *ICPI Tech Spec 12–Snow Melting Systems for Interlocking Concrete Pavements* for further information on snow melting systems.

Rigid Pavements: These pavements consist of a concrete base, a thin sand-asphalt bedding layer, an adhesive, and concrete pavers with sand-filled joints. This system is often called bitumen-set concrete pavers. Construction is slower and more expensive compared to sand-set installations. However, the result can be a very durable assembly. Draining excess water from the concrete base is accomplished with 2 to 3 in. (50 to 75 mm) diameter vertical holes through the concrete. Placed at lowest elevations, the holes are filled with washed pea gravel.

Bitumen-set concrete pavers subject to vehicular traffic follow this construction sequence. A tack coat is placed on a concrete base, the asphalt bed is placed, screeded, and then compacted. Adhesive is applied to the bed and the pavers are

placed on it. The pavers are placed on the adhesive after it is dried and the pavers are compacted onto the adhesive. The joints are filled with sand or stabilized sand. Since the compacted bitumen-sand bedding allow for no additional consolidation, concrete pavers will require plus or minus $1/16$ in. (1.5 mm) height tolerance.

Reinstatement of bitumen-set pavers is difficult because the asphalt material adheres to the bottom of the pavers when removed. Discarding removed pavers may be less expensive than removing asphalt adhered to the bottom and reinstating them. Bitumen-set concrete pavers are not recommended over asphalt bases for heavy urban vehicular applications or over aggregate bases for any application.

Mortared pavers should only be used in pedestrian areas in non-freeze-thaw areas. Mortared joints have a high risk of deterioration when subjected to vehicular traffic, freeze-thaw cycles and/or de-icing salts. Mortared pavers using liquid latex additives as thinset or thickset mixture are recommended for bonding pavers to existing concrete in pedestrian applications.

Polymer adhesives specially designed for adhering concrete pavers to concrete enable faster installation without the chance of accidentally staining the surface of the pavers with mortar. These adhesives can be used in areas with freezing climates. Pavers set with adhesives are not recommended for vehicular areas.

Mechanical Installation: Many laying patterns can be installed mechanically, saving construction time and costs compared to manual installation. Specialized installation equipment enables over a square yard (m^2) of concrete pavers to be placed in succession, rather than one paver at a time (Figure 8). Contact a local ICPI supplier for availability of laying patterns and for contractors experienced with mechanical installation equipment. See *ICPI Tech Spec 11–Mechanical Installation of Interlocking Concrete Pavements* and *ICPI Tech Spec 15–A Guide for the Specification of Mechanically Installed Interlocking Concrete Pavements* for further information on mechanical installation.

Availability and Price

Availability: Interlocking concrete pavers are available from ICPI members throughout the U.S. and Canada. ICPI members can be located by visiting www.icpi.org. Check with a local member for available shapes, thicknesses, and colors.

Price: Prices vary depending on the site location, local competition, pattern, thickness, color, area, base requirements, edge restraints, installation method and drainage.



Figure 8. Mechanical installation equipment places concrete pavers rapidly.

Warranty

Contractors typically offer warranties on workmanship as well as material supplier warranties. Details should be confirmed with installation contractor. ICPI paver suppliers will typically provide laboratory test results demonstrating that the specified product meets the requirements of ASTM C936 or CSA A231.2 as applicable.

Maintenance

When properly installed, interlocking concrete pavements require little maintenance. As with all pavements, they will become soiled over time depending on the amount of use. Contact a local ICPI supplier for information on cleaning concrete pavers. ICPI publishes other technical bulletins on cleaning, sealing, including *ICPI Tech Spec 5—Cleaning, Sealing and Joint Sand Stabilization of Interlocking Concrete Pavements* and *ICPI Tech Spec 6—Reinstatement of Interlocking Concrete Pavements*. Unlike conventional pavements, interlocking concrete pavers can be reinstated after repairs thereby avoiding disposal costs and related environmental impacts. This provides lower down times and user costs especially on high use urban roads and sidewalks.

Management of interlocking concrete pavement can be accomplished using ASTM E2840 *Standard Practice for Pavement Condition Index Surveys for Interlocking Concrete Roads and Parking Lots*. This practice establishes survey procedures for determining the condition and wear severity of

interlocking concrete pavements. The guide develops a pavement condition index or PCI value for the pavement that can be used to forecast when maintenance might be required. The PCI also enables performance comparisons to asphalt and concrete streets since ASTM E2840 uses evaluation methods similar to another ASTM standard used to evaluate asphalt and concrete pavements.



Interlocking Concrete
Pavement Institute®

14801 Murdock Street
Suite 230
Chantilly, VA 20151

In Canada:
P.O. Box 1150
Uxbridge, ON L9P 1N4
Canada

Tel: 703.657.6900

Fax: 703.657.6901

E-mail: icpi@icpi.org

www.icpi.org

The content of ICPI Tech Spec technical bulletins is intended for use only as a guideline. It is not intended for use or reliance upon as an industry standard, certification or as a specification. ICPI makes no promises, representations or warranties of any kind, expressed or implied, as to the content of the Tech Spec Technical Bulletins and disclaims any liability for damages resulting from the use of Tech Spec Technical Bulletins. Professional assistance should be sought with respect to the design, specifications and construction of each project.

BOD Approved: August 2015